

# INSTALLATION/INSTALACIÓN/POSE

Install blade to arm, unless grid below shows extra adapter required for arm type./Instale la hoja en el brazo, a menos que la tabla de más abajo indique que hace falta un adaptador adicional para el tipo de brazo./Installer le balai sur le bras, à moins que le tableau ci-dessous n'indique qu'un adaptateur soit nécessaire pour ce type de bras.

Measure hook size/Mida el tamaño del gancho/Mesurer la largeur du crochet

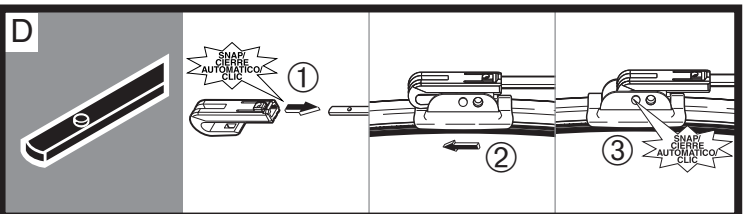
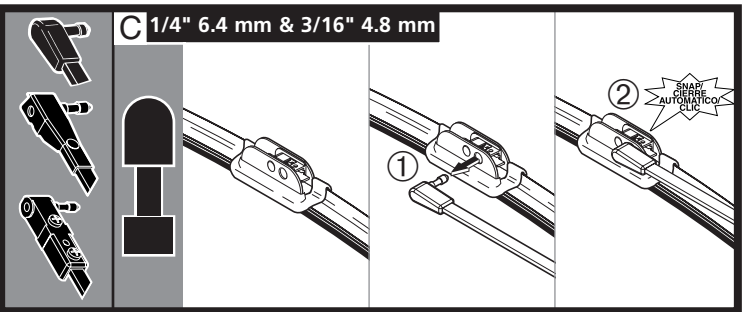
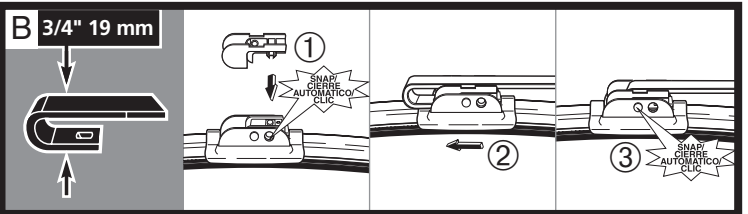
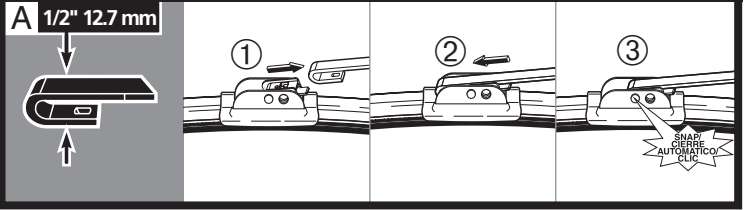

Adapters Included Incluye los adaptadores Adaptateurs fournis	Blade Length/Largo de la hoja/Longueur du balai									
	16	17	18	19	20	21	22	24	26	28
				B	B	B	B	B	B	
	D		D							

1 Inch	25.4 mm
3/4"	19 mm
1/2"	12.7 mm
1/4"	6.4 mm
3/16"	4.8 mm

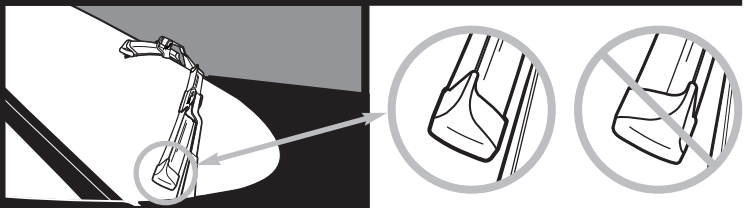
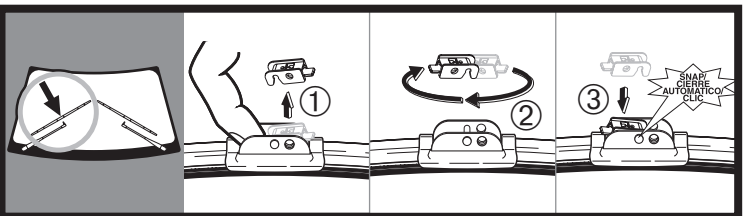

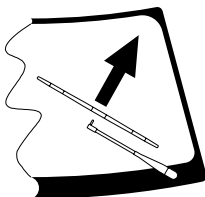

## REMOVAL / EXTRACCIÓN / DÉPOSE

Identify arm type (A, B, C, or D) and follow easy steps to remove wiper blade.  
 Identifique el tipo de brazo (A, B, C, o D) y siga los pasos fáciles para extraer la hoja del limpiaparabrisas.  
 Identifier le type de bras (A, B, C, ou D) puis enlever la lame d'essuie-glace en suivant les instructions simples.

